

Combo Tester Installation, Operation and Maintenance



Made in the
United States of America



Figure 1. Charleswater [99037](#) Combo Tester

Description

The Charleswater Combo Tester verifies the functionality of an operator’s wrist strap and footwear (footwear test requires foot plate). It determines if an operator’s wrist strap and footwear will function correctly. A rocker switch allows the operator to select a wrist strap or footwear test. A green light indicates that the wrist strap or footwear is passing. Red and yellow lights plus an audible alarm indicate when the wrist strap or footwear is failing. If failure occurs, the tester will also display if the grounding device’s resistance is too low or too high.

The factory test limits are set to:

- Wrist Straps: 750 kilohms and 35 megohms
- Footwear: 750 kilohms and 35 megohms

Contact [Charleswater Customer Service](#) if custom test limits are required.

The Combo Tester is powered by a 9 volt battery. A warning light on the tester indicates when the battery power is too low and affecting the test results.

Each Combo Tester is calibrated with accepted procedures and standards traceable to the National Institute of Standards and Technology (NIST) and includes a NIST certificate.

This product meets EN 61340-5-1 Annex A Test methods, and can be used as one of the tools to fulfill EN 61340-5-1 Compliance verification requirements “Process monitoring (measurements) shall be conducted in accordance with a compliance verification plan that identifies the technical requirements to be verified, the measurement limits and the frequency at which those verifications must occur. ... Compliance verification records shall be established and maintained to provide evidence of conformity to the technical requirements. The test equipment selected shall be capable of making the measurements defined in the compliance verification plan.”

“Wrist straps should be tested periodically. The frequency of testing, however, is driven by the amount of usage, wear and ESD risk exposure that can occur between tests. For example, what is the quantity of product handled between test periods? Typical test programs recommend that wrist straps that are used daily should be tested daily. However, if the products that are being produced are of such value that a guarantee of a continuous, reliable ground is needed then continuous monitoring should be considered or even required.” (CLC TR 61340-5-2 User guide Wrist Strap clause 4.7.2.4.4 Test frequency)

“The operator shall wear the wrist strap in the normal position and plug the free end of the cord into the test apparatus. The hand contact plate shall be pressed to verify that the wrist strap system resistance is within acceptable parameters. The test apparatus can be an integrated, commercially available tester. (EN 61340-5-1 Annex A Test method A.1 Measurement method for wrist strap testing)

“The operator shall stand with one foot on the conductive footwear electrode. The hand contact plate shall be pressed to verify that the person footwear system resistance is within acceptable parameters. The test shall be repeated for the other foot. The test apparatus can be an integrated, commercially available tester.” (EN 61340-5-1 Annex A Test method A.2 Measurement procedure for footwear testing)

Item	Description
99037	Combo Tester
99038	Combo Tester with Stand and Foot Plate
99013	Stainless Steel Foot Plate

Packaging

99037 COMBO TESTER

- 1 Combo Tester
- 1 Foot Plate Cord, 5 inches
- 1 [80020](#) Banana Plug / 10 mm Adapter
- 1 9V Battery
- 1 Certificate of Calibration

99038 COMBO TESTER WITH STAND AND FOOT PLATE

- 1 Combo Tester
- 1 Foot Plate Ground Wire, 5 inches
- 1 [80020](#) Banana Plug / 10 mm Adapter
- 1 9V Battery
- 1 Foot Plate
- 1 Pedestal
- 3 Button Head Screws, 1/4-20 x 3/4"
- 1 Allen Wrench, 5/32"
- 1 Flat Head Screw, 8-32 x 5/8"
- 1 Knurled Nut, 8-32
- 1 Black Cap
- 1 Poster
- 1 Certificate of Calibration

Both the [99037](#) and [99038](#) Combo Testers include a Charleswater [80020](#) 10 mm Adapter. This is used to convert the banana jack on the face of tester to a 10 mm snap. Note that this adapter is permanent and cannot be removed once it is installed.



Figure 2. Charleswater [99038](#) Combo Tester with Stand and Foot Plate

99013 STAINLESS STEEL FOOT PLATE

- 1 Stainless Steel Foot Plate
- 1 Foot Plate Cord, 6 feet



Figure 3. Charleswater [99013](#) Stainless Steel Foot Plate

Features and Components

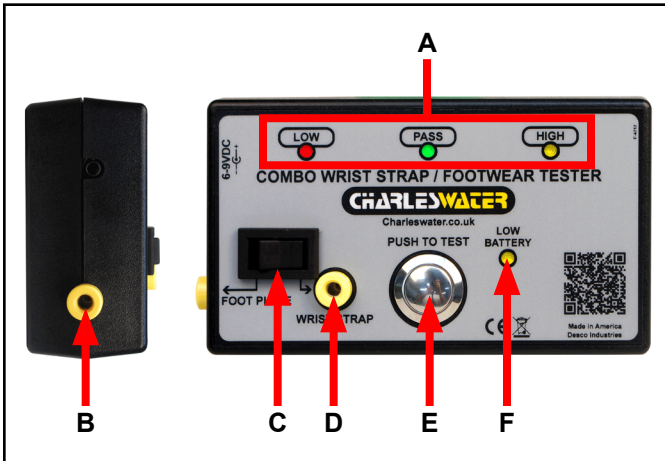

Figure 4. Combo Tester features and components

- A. Test Result LEDs:** Displays the test results.
- B. Foot Plate Jack:** Connect the banana plug terminal of the foot plate cord here and the other end to the pedestal (99038) or stainless steel foot plate (99013).
- C. Rocker Switch:** Toggle to the left when performing a footwear test. Toggle to the right when performing a wrist strap test.
- D. Single-Wire Wrist Strap Jack:** Insert your single-wire wrist cord here to test your wrist strap.
- E. Test Switch:** Push down and hold your finger here to perform a test.
- F. Low Battery LED:** Illuminates when the battery power is low and needs to be replaced.

Installation

The Combo Tester is portable, but it also has the flexibility of being permanently installed at a location. Use the three keyhole slots located on the back of the Combo Tester to mount it to a wall or stand.

INSTALLING THE 99037 COMBO TESTER

1. Install the 9V alkaline battery into the Combo Tester.
2. Select a location to mount the Combo Tester.
3. Install three #6 or #8 screws into a wall or other vertical surface as shown in the figure below. Make sure that the screw heads do not project out more than 1/4" from mounting surface.

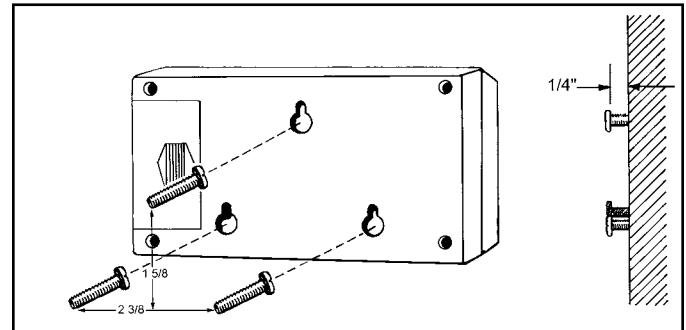

Figure 5. Combo Tester keyhole slots

4. Mount the Combo Tester onto the screws, and pull it down to secure it into place.
5. Set the Stainless Steel Foot Plate below the tester (if applicable).
6. Insert the 6' long foot plate cord's banana plug into the Combo Tester's foot plate jack.

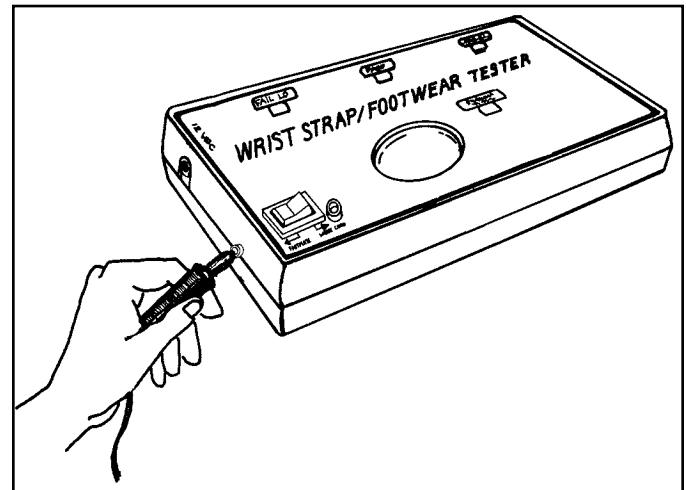

Figure 6. Inserting the foot plate cord's banana jack into the Combo Tester

7. Snap the opposite end of the foot plate cord onto the Stainless Steel Foot Plate.

INSTALLING THE [99038](#) COMBO TESTER WITH STAND AND FOOT PLATE

1. Position the pedestal on top of the foot plate with the mounting bracket sloping toward the operator. Secure the pedestal to the foot plate using the 3 included button head screws and allen wrench.

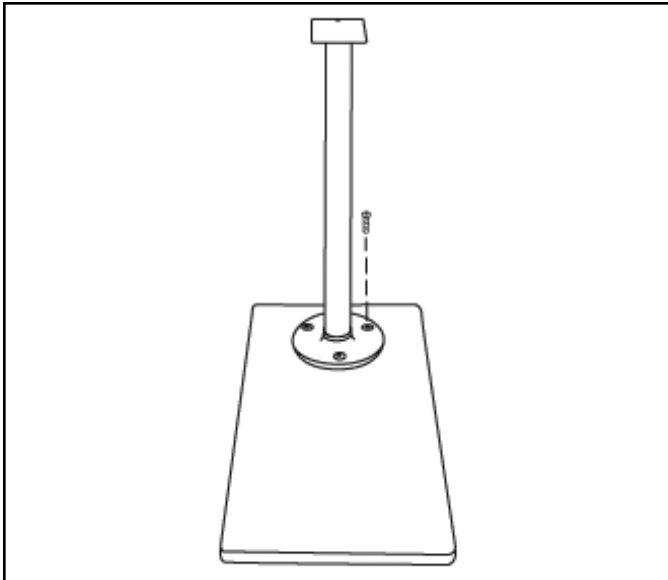

Figure 7. Securing the pedestal to the foot plate

2. Install the 9V alkaline battery into the Combo Tester.
3. Mount the Combo Tester onto the pedestal's mounting bracket and flat head screw, and screw down to secure it into place.
4. Insert the 5" long foot plate cord's banana plug into the Combo Tester's foot plate jack.
5. Attach the foot plate cord's ring terminal to the flat head screw located at the back of the pedestal's mounting bracket, and tighten the knurled nut to secure.

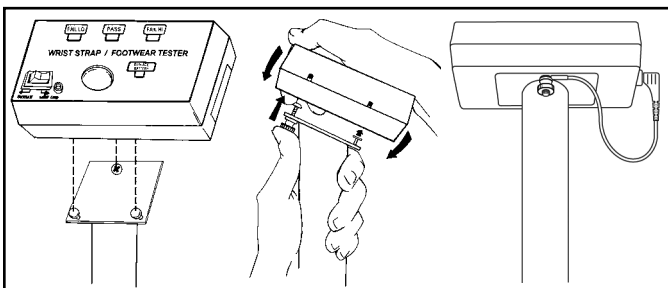

Figure 8. Installing the Combo Tester to the pedestal

6. Cover the knurled nut and flat head screw with included insulative vinyl cap.
7. Install the included poster at eye level nearby the test station.

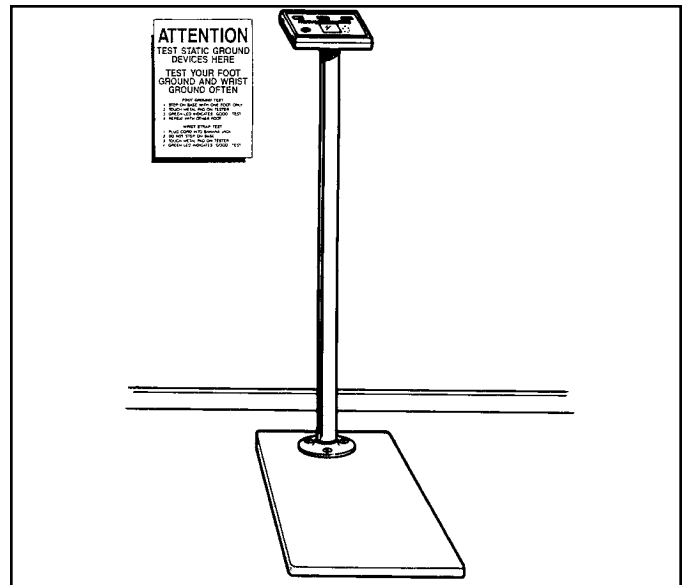

Figure 9. Completed Combo Tester with Stand and Foot Plate assembly

Operation

WRIST STRAP TEST

1. While wearing a wrist strap, plug the wrist cord into the wrist strap jack located on the face of the Combo Tester.
2. Toggle the rocker switch to the right toward WRIST STRAP.
3. Push down and hold the test switch until the test results are displayed. DO NOT touch any other metal while performing your test as this will affect your results.

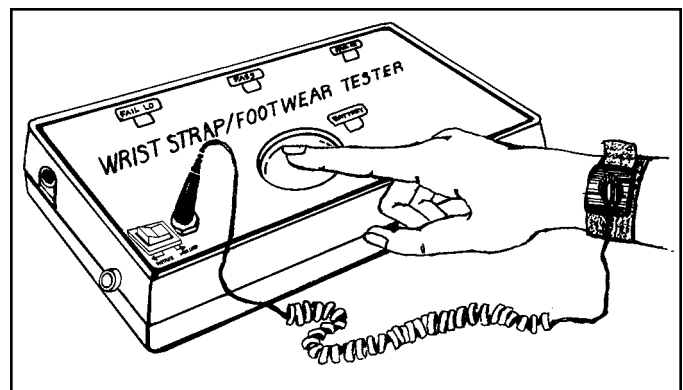

Figure 10. Performing a wrist strap test

4. A "PASS" test result is indicated by illumination of the green LED. A "FAIL LOW" test result is indicated by illumination of the red LED. A "FAIL HIGH" test result is indicated by illumination of the yellow LED.

If your ESD test fails, check your wrist strap and ensure that it is being worn correctly and/or needs to be replaced.

NOTE 1: The Combo Tester may briefly display "FAIL HIGH" once the test button is released at the conclusion of a test. Residual voltage in the circuit's capacitors causes the test to continue for a split second after the button is released.

NOTE 2: Failures may be caused by dry skin or minimal sweat layer. For wrist straps, try using an approved dissipative hand lotion such as [Menda Reztore™ ESD Hand Lotion](#) to your wrist prior to use.

The Combo Tester may also be used to test smocks or garments that feature a grounding mechanism for operators using a coiled cord connection.

FOOTWEAR TEST

1. Toggle the rocker switch to the left toward FOOT PLATE.
2. While wearing ESD footwear, place one foot on the foot plate, and lift the second foot off the floor. Make sure there is no wrist cord plugged into the WRIST STRAP jack.
3. Push down and hold the test switch until the test results are displayed. DO NOT touch any other metal while performing your test as this will affect your results.

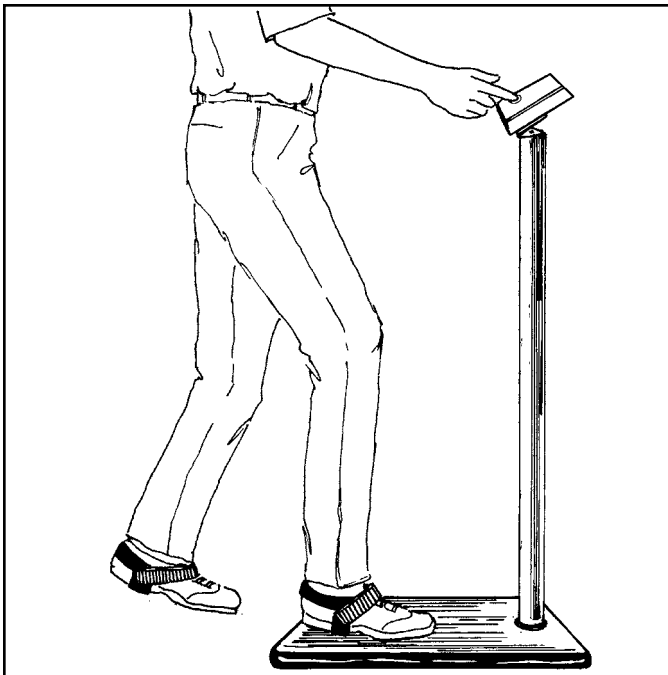

Figure 11. Performing a footwear test with the [99038 Combo Tester with Stand and Foot Plate](#)

4. A "PASS" test result is indicated by illumination of the green LED. A "FAIL LOW" test result is indicated by illumination of the red LED. A "FAIL HIGH" test result is indicated by illumination of the yellow LED.

If your ESD test fails, check your footwear and ensure that it is being worn correctly and/or needs to be replaced.

NOTE 1: The Combo Tester may briefly display "FAIL HIGH" once the test button is released at the conclusion of a test. Residual voltage in the circuit's capacitors causes the test to continue for a split second after the button is released.

NOTE 2: Failures may be caused by dry skin or minimal sweat layer. Footwear test results can be improved by taking a short walk to build a sweat layer for better conductivity.

5. Repeat steps 2-4 for the second foot.

Maintenance

The Combo Tester requires little maintenance. There are no user serviceable parts. If your meter requires service beyond cleaning the test switch or foot plate, please contact the factory.

Use a minimum of 80% isopropyl alcohol to clean the test switch. Other cleaners are susceptible to leaving residue.

BATTERY REPLACEMENT

The low battery indicator flashes briefly every time the unit is used. Replace the battery once the indicator becomes constant during testing. Open the compartment located on the back of the tester to replace the battery. The tester uses one 9V alkaline battery.

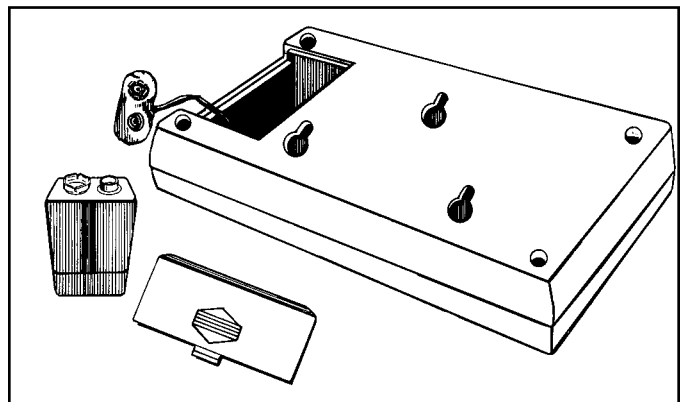

Figure 12. Replacing the battery

Calibration

The Charleswater Combo Tester is calibrated to NIST traceable standards. There are no user adjustments necessary. We recommend that calibration be performed annually using the Charleswater [99090](#) Calibration Unit. It is a convenient product which allows the customer to perform NIST traceable calibration on single-wire personnel testers. The [99090](#) is designed to be used on the shop floor at the workstation, virtually eliminating downtime, verifying that the tester is operating within tolerances.

View technical bulletin [PPE-5034.E](#) for more information on the [99090](#) Calibration Unit and instructions to calibrate the Combo Tester.



Figure 13. Charleswater [99090](#) Calibration Unit

Specifications

COMBO TESTER

Power Supply	9V Alkaline Battery
Operating Temperature	32°F to 104°F (0 to 40°C)
Wrist Strap Test Limit:	750 kilohms to 35 megohms
Footwear Test Limit:	750 kilohms to 35 megohms
Test Accuracy:	±20%
Test Voltage	4 VDC
Dimensions	3.3" x 5.6" x 1.5" (8.4 cm x 14.2 cm x 3.8 cm)
Weight	0.5 lbs (0.2 kg)

STAND AND FOOT PLATE

Stand Height	36" (91 cm)
Foot Plate Dimensions	18" x 12" x 1" (46 cm x 30 cm x 3 cm)
Weight	8.0 lbs (3.6 kg)

STAINLESS STEEL FOOT PLATE

Dimensions	20" x 20" x 0.5" (51 cm x 51 cm x 1 cm)
Weight	5.5 lbs (2.5 kg)

Limited Warranty, Warranty Exclusions, Limit of Liability and RMA Request Instructions

See Charleswater's Warranty - <http://www.charleswater.co.uk/LimitedWarranty.aspx>